

Originalbetriebsanleitung
Gebrauchsanweisung

Original instructions
Instruction manual

Notice originale
Instructions d'emploi

Manual original
Manual del usuario

Istruzioni originali
Istruzioni d'impiego

Oorspronkelijke gebruiksaanwijzing
Gebruiksaanwijzing

Motor-Hochdruckspritze

**Motorized high pressure
sprayer**

**Pulvérisateur à moteur
portable à dos**

**Pulverizador a motor de
mochila**

**Spruzzatore ad alta
pressione a motore**

**Motoraangedreven
hogedrukspuit**

de

en

fr

es

it

nl

Achtung!

Lesen Sie vor der ersten Inbetriebnahme diese Gebrauchsanweisung und die separate Motor-Gebrauchsanweisung gründlich durch und beachten Sie unbedingt die Sicherheitsvorschriften!

Important!

Before using this power tool for the first time, please make sure that you read these operating instructions and the separate operating instructions for the engine carefully and follow all the warnings and safety instructions.

Attention!

Avant la première mise en service, lisez attentivement ce mode d'emploi ainsi que la notice spéciale du moteur. Respectez absolument les consignes de sécurité.

¡Atención!

Antes de poner en marcha este aparato lea atentamente el manual de uso y el manual de uso separado del motor y respete siempre las normas de seguridad.

Attenzione!

Prima della prima messa in funzione leggere a fondo le presenti istruzioni per l'uso, le istruzioni per l'uso del motore fornite separatamente, e osservare assolutamente le norme di sicurezza.

Opgelet!

Lees deze gebruiksaanwijzing en de afzonderlijke motor-gebruiksaanwijzing grondig voor u de machine voor het eerst gebruikt en hou altijd rekening met de veiligheidsvoorschriften!



Instruction manual

Original instructions

 **Caution!** Before using this power tool for the first time, please make sure that you read these operating instructions and the separate operating instructions for the engine carefully and follow all the warnings and safety instructions.

To ensure that your device will continue to work properly and deliver optimum performance for many years to come, ensure that you follow all instructions in this operating and maintenance manual.

Your dealer will be glad to assist you with any questions.

 This machine produces an electromagnetic field during operation. This field may under some circumstances interfere with active or passive medical implants. Persons with medical implants have to consult their physician and the medical implant manufacturer before operating this machine.

EC declaration of conformity → The EC declaration of conformity on a separate piece of paper forms part of these operating instructions.

Packaging and disposal

Please keep the original packaging in order to protect the equipment against transport damage in case you ever need to ship it or transport it. If the packaging materials are no longer required then they must be disposed of properly in accordance with applicable local regulations. Cardboard packaging materials are raw materials which can be recycled or reused.

At the end of the equipment's service life, please make sure that you dispose of it properly, in accordance with the official directives and regulations that apply in your area







Type plate



- a: Type designation
- b: Serial number
- c: Build year

Symbols

The following symbols are used in this manual and on the product:

-  Thoroughly read these operating instructions before undertaking any maintenance, installation and cleaning steps
-  Always handle this power tool with particular care
-  Wear the prescribed protective clothing.
-  Wear ear defenders before starting the engine
-  Wear face protection (e.g., safety goggles).
-  Wear protective gloves when handling and working with the equipment
-  A breathing mask should be worn when using poisonous chemicals
-  Petrol is highly flammable
-  Keep open flames away from the power tool and the fuel can.
-  Never smoke near the power tool or where the equipment is refuelled!
-  No-one else may remain in the vicinity of the motor appliance whilst it is operating.
-  Switch off engine

Information about material ingredients (VO (EC) No.1907/2006 „REACH“) can be found on our homepage under: <https://de.solo.global/de/content/12-service>
Exhaust emission level

The CO₂ value determined in the EU type-approval process can be found on our homepage under: <https://de.solo.global/de/content/12-services>

National requirements

The pressure sprayer may be subject to national requirements for regular inspection by designated bodies, as provided for in Directive 2009/128/EC¹.

¹ Directive 2009/128/EC of the European Parliament and of the Council of 21 October 2009 establishing a framework for Community action to achieve the sustainable use of pesticides

Index

| | Page |
|---|-----------|
| 1. Parts subject to wear and tear | 3 |
| 2. Safety regulations | 4 |
| 2.1 <i>Correct use / Application</i> | 4 |
| 2.2 <i>General safety instructions</i> | 4 |
| 2.3 <i>Safe handling of spray pesticides</i> | 5 |
| 2.4 <i>Personal protective equipment for your safety</i> | 5 |
| 2.5 <i>Transporting the sprayer</i> | 5 |
| 2.6 <i>Fuelling</i> | 6 |
| 2.7 <i>Preparation for starting</i> | 6 |
| 2.8 <i>Starting</i> | 6 |
| 2.9 <i>Working with the machine</i> | 7 |
| 2.10 <i>Irregularities, incidents, accidents</i> | 7 |
| 2.11 <i>Maintenance and repairs</i> | 7 |
| 2.12 <i>Protection of Environment</i> | 7 |
| 3. Standard delivery | 8 |
| 4. Control and function elements | 8 |
| 5. Assembly | 9 |
| 6. Adjusting the carrying straps | 9 |
| 7. Fuelling | 9 |
| 7.1 <i>Model with a Honda 4-stroke engine</i> | 9 |
| 7.2 <i>Fuelling</i> | 9 |
| 8. Prior to first use and after extended storage periods | 10 |
| 9. Preparation of spray chemicals, filling of liquid container | 10 |
| 10. Starting / Stopping the engine | 12 |
| 10.1 <i>Preparation for starting</i> | 12 |
| 10.2 <i>Starting</i> | 12 |
| 10.3 <i>Stopping engine:</i> | 13 |
| 11. Use of High Pressure Pump | 14 |
| 11.1 <i>Scope of Application</i> | 14 |
| 11.2 <i>Pressure Regulation</i> | 14 |
| 11.3 <i>Spray nozzle / Output volume</i> | 15 |
| 11.4 <i>Excess spray chemical / Completing spraying operation</i> | 15 |
| 11.5 <i>Spray tube holder</i> | 15 |
| 12. Operating and maintenance instructions | 16 |
| 12.1 <i>General operating and maintenance instructions</i> | 16 |
| 12.2 <i>Engine components</i> | 16 |
| 12.3 <i>Checking output volume of spray chemical</i> | 16 |
| 12.4 <i>Emptying and cleaning liquid tank</i> | 17 |
| 12.5 <i>Shutdown and storage</i> | 17 |
| 12.6 <i>Scheduled maintenance</i> | 18 |
| 13. Technical Specifications | 19 |
| 14. Guarantee | 19 |

1. Parts subject to wear and tear

Various parts are subject to application-specific wear or to normal wear and must be replaced in good time if necessary. The following parts are subject to normal wear and are not covered by the manufacturers guarantee:

- Air filter
- Fuel filter
- All rubber parts which come into contact with the spray liquid
- Spark plug
- Starter

2. Safety regulations

2.1 Correct use / Application

- Use the device only for the application of liquid herbicides, pesticides and weed killers as well as liquid fertilisers that are available from the authorised specialist trade and approved by local/national authorities for use with portable spraying devices and for the application of clean water.
- Strictly observe the information on the spraying agent, in particular instructions on personal protective equipment.
- Application areas are in farming, tree nurseries, forest operations, orchards, vineyards, market gardens, as well as glasshouse cultures with sufficient ventilation and venting.
- The device must not be used for any other purposes, such as application of other agents from the above liquids! In particular, no acids, alkalis, solvent-containing liquids and waterproofing agents must be applied.
- Never use any liquids with temperatures above 40 °C [104 °F].
- Do not use any flammable agents.

2.2 General safety instructions



Before using the tool for the first time, make sure that you read these operating instructions and the separate operating instructions for the engine carefully. These operating instructions must be kept in a safe place. Always take great care when using this power tool.

Non-observance of safety instructions can lead to a risk to life. Also observe any regulations from your professional body. These operating instructions must always be available at the place of work. All individuals instructed to work with the equipment (including maintenance, care and repair), should read these instructions.



The operator is liable towards others within the operating area of the device.

Only operate the device when in good physical condition, well rested and healthy. Fatigue and illness lead to carelessness and accidents. Proceed in a careful and alert manner.

- You should request and receive instructions from the vendor on the safe operation if you are using this type of product for the first time.
- Children and persons under the age of 18 are not allowed to use this machine.
- No other persons or animals should be within the work area. Never spray towards other persons, animals or objects which would suffer damage. The sprayer generates high pressure at the nozzle which may be dangerous. The operator is responsible for any accidents or damage caused towards other persons or property.
- This High Pressure Sprayer may only be passed on or lent to other persons if that person is familiar with the safe use of this product and is familiar with the instruction manual. Always supply the manual with the machine.
- Ensure you are rested and in good health when using this product.
- Persons under the influence of alcohol or drugs, including prescription drugs, are not allowed to use the machine as their ability to quickly react to potential danger may be impaired.
- Never alter, change or modify any safety equipment or functional assemblies on this machine.
- The engine driven sprayer should only be used when the unit is in good, safe condition. Always check the machine prior to use. **Danger of Accident!**
- Only use parts and accessories which were approved and supplied by the manufacturer.
- The reliability and safe operation of your machine depend on the quality of parts used with the machine. Only use original spare parts. Original spare parts are identical with genuine production parts and guarantee best quality in material, measurements, function and safety. Original parts and accessories are available from your specialist dealer. Your specialist dealer has been supplied with correct documentation to determine the correct parts. The specialist dealer is frequently supplied with updates about improvements to the equipment. Please note that the use of non-original parts will void your warranty.
- Always store the machine in a safe place and in such a way that it will not pose any danger. Stop the engine when the machine is not used. Drain and clean the liquid tank according to the details provided in section 13.4 "Draining and cleaning liquid tank". Unauthorized persons should have no access to the machine.

Persons who disregard safety instructions, operating instructions or maintenance instructions may be liable for any damage or consequential damage.

2.3 Safe handling of spray pesticides

- Avoid contaminating the environment, the mains water supply and/or public sewer systems with spraying agent or cleaner!
Ensure to avoid contamination when mixing, filling, using, draining, cleaning, servicing and transporting by using adequate procedures and suitable containers.
- Pesticides must never be allowed to enter public sewer systems, sprayed onto wastelands, allowed to drain into natural bodies of water or disposed of together with normal domestic waste. This also means that appropriate care must be taken during filling to ensure that none of the pesticide is drawn back into water pipes. Pesticides and any unused leftovers of pesticides must always be collected in a suitable container and disposed of via approved facilities for household chemical waste. Please contact your local authorities for information about your nearest disposal facilities.
- Avoid any direct contact with pesticides. In case of contact with harmful pesticides rinse the affected body parts immediately with plenty of water, any clothing soaked with spraying agents should be changed immediately, seek medical advice if needed.
- Stop working immediately if you start to feel unwell while working, or if you become unusually tired. Seek medical advice if the condition persists.
- Never allow children or anybody who is not familiar with handling this type of spraying agent to handle the spraying agent.
- Clean the solution tank whenever the spraying agent is changed. Run the backpack sprayer with clear water after cleaning the solution tank – but before the next spraying agent is filled – flush out any residue from the pump and the hoses. This will prevent the risk of any chemical reactions taking place between the different substances.
- Never spray in narrow or enclosed spaces – pesticides are toxic and there is a risk of poisoning. Spraying equipment must for example only be used in greenhouses if adequate ventilation is provided. Signs must be put up in greenhouses that have been treated. Nobody should enter the greenhouse again until it has been thoroughly ventilated.
- When you have finished spraying, follow the steps in section 13.4 "Draining and cleaning the solution tank" to prepare the device for storage, thoroughly wash your face and hands with soap, take off your work clothing and ensure that it is washed regularly.
Any unused pesticide that is left over in the device could cause corrosion and hence damage the device. Special attention must be paid to wearing parts like nozzles, filters and seals.

2.4 Personal protective equipment for your safety



Always wear appropriate clothing and protective equipment whenever this power tool is used.

Wear appropriate protective clothing which covers all body parts. This includes gloves, head protection, foot protection, body protection and possibly an apron or breathing mask. Clothing should be suitable, i.e. tight without being obstructive.

Do not wear a scarf, necktie, jewellery or any clothing which can get caught on shrubs or branches.

- Wear firm shoes with good traction, preferably safety shoes.



Wear protective gloves with non-slip grip.



Use personal ear protection (such as ear muffs, ear plugs or similar) and a face mask or safety goggles to protect against spray drift or airborne debris.



Always wear a breathing mask when working in dense and tall plants, in greenhouses, in dips in the ground or in trenches and when using dangerous spraying agents.

- Any clothing soaked with spraying agents or petrol should be changed immediately.
- Wash the work clothing regularly.

2.5 Transporting the sprayer

- Always stop the engine to transport the sprayer.
- Considering road traffic hazards it is advisable to secure the sprayer firmly and safely before transporting the unit.
- Ensure there are no chemical or petrol leaks. Always check the chemical tank, pump, fuel tank and all hoses and pipes for the chemical solution and fuel supply for leakage. Prior to transporting the sprayer, drain the chemical tank as per instructions provided in section 13.4 "Draining and cleaning chemical tank".

2.6 Fuelling



Petrol is very light and highly flammable. Keep away from open flames and never spill fuel. Do not smoke at the operating site or at and near the refuelling site!

- Stop the engine prior to refuelling.
- Let the engine cool down before refuelling - fire risk!
- Open the tank lid slowly to allow any excess pressure in the tank to be reduced without the risk of petrol spraying out.
- Fuel may contain substances similar to solvents. Prevent products made from mineral oil coming into contact with skin and eyes. Wear protective gloves during filling with fuel. Frequently change and clean protective clothing.
- Avoid breathing in fuel vapour.
- The refuelling site should be well ventilated.
- Avoid any soil spillage of fuel or oil (protection of the environment). Use a suitable mat.
- Immediately clean any spilled fuel on the machine. Change contaminated clothing without delay.
- Firmly tighten all tank lids. This will reduce the risk of spillage from lids, which have become loose from engine vibrations.
- Check for petrol leaks. Do not start the machine or work with the machine if there is a petrol leak. Life threatening risk from burns!
- Store fuel and oil in approved and correctly labelled containers.

2.7 Preparation for starting

Check the complete machine for operational safety.

- The stop button should function properly.
- The throttle lever has to move easily and smoothly.
- Check the chemical tank, pump, fuel tank and all hoses and pipes for chemicals and fuel for possible leakage.
- Ensure the spark plug cap and the ignition cable are connected firmly. A loose connection may cause a spark which can ignite any existing fuel-air mixture - fire hazard!
- Should the check reveal any irregularities or recognizable damage (also to the frame), incorrect adjustments or reduced efficiency of the machine, do not commence work. Take the motorized high pressure sprayer to a specialized workshop and have it checked.

2.8 Starting

- Start the machine no less than 3 metres from the refuelling location. Never start the machine in an enclosed area.
- Ensure secure, firm footing for starting.
- Only one person is allowed to operate the motorized high pressure sprayer. No other person should be within 5 meters when the machine is started or operated.
- The trigger handle on the spray wand should be closed during the starting process. Ensure the spray wand is directed away from persons and objects.
- Continue with the starting procedure as described in section 11. "Starting engine / Stopping engine".

2.9 Working with the machine

While running, the engine produces toxic exhaust gas which is odourless and invisible. Never start or operate the machine in closed rooms. Ensure for adequate ventilation in confined areas such as ditches or dips. Remain within calling distance to other persons who would be able to provide assistance if needed. Provide for regular and in-time rest periods.



Do not smoke in the vicinity of the machine or at the work site. Smoking increases the danger of fire!

- Operate the machine with as little noise and exhaust gas emission as possible - only run the engine when necessary. Consider that noise is an environmental hazard. Respect and observe any quiet periods which may vary locally.
- Do not touch the muffler and exhaust while still hot. Danger of burns!
- Never operate the machine without a muffler or with a damaged muffler. Danger of burns and loss of hearing!
- The machine should be stopped when not in use and secured to prevent danger of injury to others.

2.10 Irregularities, incidents, accidents

- In case of irregularities, leaks, visible damage or reduced efficiency, do not commence work, but leave the unit from a dealer check.
- When irregularity, leaks or malfunctions occur during operation, turn off the stop switch immediately and put the machine on the ground immediately. The device may only be used again if it is checked by a specialist workshop and the cause of the fault has been eradicated.
- In case of serious disturbances or accidents during operation of the unit as smoke, strong odors from the device or the device is in flames instantly remove the unit from your body and take a safe distance. In case of fire, you have to call the fire department immediately.

2.11 Maintenance and repairs

The power tool must be serviced on a regular basis. Only perform maintenance work or repairs yourself if the work is described in these operating instructions or in the separate operating instructions for the engine. All other work must only be performed by an authorised workshop

- Do not maintain, repair or store the machine in the vicinity of an open flame.
- Always stop the engine before attempting any cleaning, repair or maintenance jobs. An exception is the adjustment of the carburettor or idling speed.
- Only remove the pressure hose (14), the trigger handle (15), the spray wand (17) and the nozzle insert (18) when the engine has been switched OFF and the system is fully depressurised. To achieve this, with the engine switched OFF, insert the spray wand (17) into the liquid tank or into a container suitable for the liquid concerned, and operate the trigger handle (15).
- For any repairs only use original parts from the manufacturer.
- Do not modify, alter or change the machine as this may impact on the safety of and with the machine and lead to accidents and injury!

2.12 Protection of Environment

Be aware of your surroundings!

- Watch out for persons and animals which may be within your work area
- Be aware that noise is harmful to the environment. Inquire about and respect possible local rest periods.
- Avoid contaminating the environment, the mains water supply and/or public sewer systems with spraying agent, cleaner, fuel and oil! Ensure to avoid contamination when mixing, filling, using, draining, mixing and filling-in the fuel mixture, cleaning, servicing and transporting by using adequate procedures and suitable containers.
- When applying spraying agent, ensure by using appropriate measures and procedures that the unintended release of agent to other areas is minimized and the drift to the surrounding areas is prevented.

3. Standard delivery

- Basic unit
 - Complete unit but without spray wand
- Spray wand with pre-assembled nozzle set
- 1x **sticker** for the solution container for each of the following: Herbicide, Fungicide and Insecticide.
- These **operating instructions** and the separate **engine operating instructions**
- The **EC declaration of conformity** on a separate piece of paper

4. Control and function elements

Engine unit: (depending on the version)

Model with a Honda 4-stroke engine →

Always comply carefully with the specifications in the separate operating instructions for the engine.

1. Choke lever
2. Spark plug cap
3. Muffler
4. Fuel tank lid
5. Starter handle
6. Air filter
7. Primer
8. Throttle adjustment lever
9. Stop button
10. Pressure regulator

Spray equipment:

11. Liquid tank
12. Tank lid -
Opening to fill liquid into tank
(Removable filter basket is supplied in the filler opening.)
13. Lid for drainage of spray liquid
14. Pressure hose
15. Trigger handle
16. Pressure gauge
17. Spray wand
18. Nozzle insert

In the best interest of continued technological progress we reserve the right to change the design and configuration of any product without prior notice.

For that reason, no claims can be accepted with reference to text and illustrations in this manual.

Fig. 1 (with SOLO-2-stroke-engine)

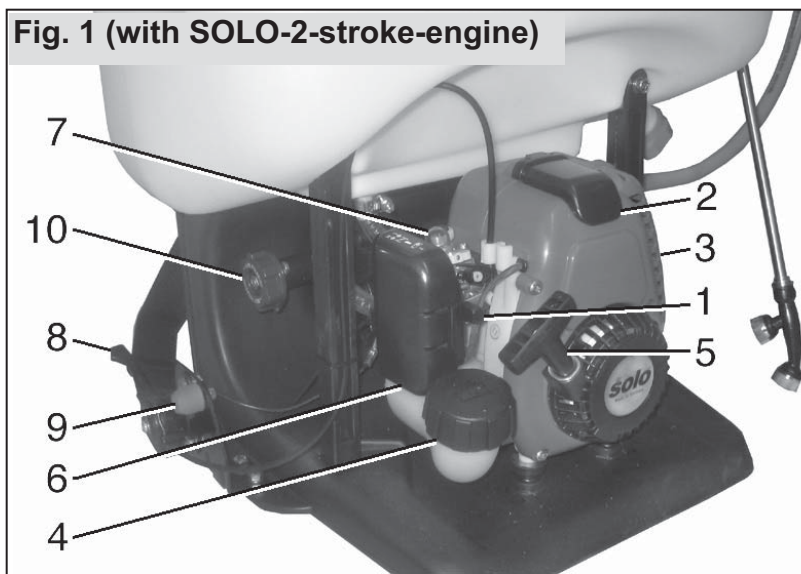

(schematic diagram / depending on the version)

Fig. 2

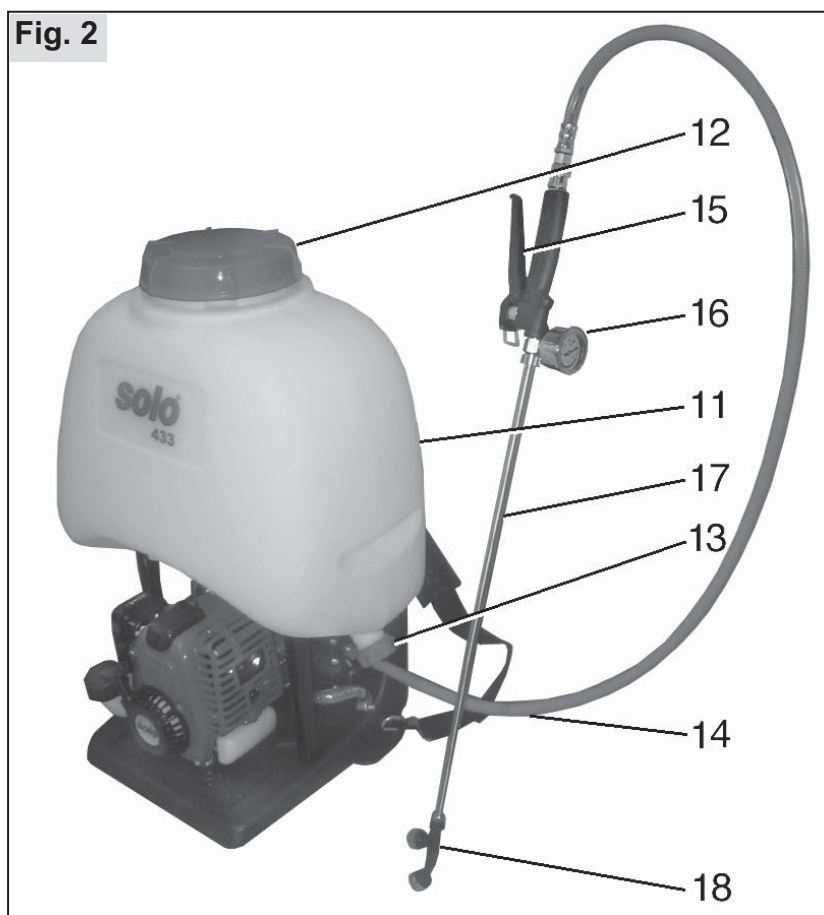

(schematic diagram / depending on the version)

5. Assembly



The high pressure sprayer may only be used after complete assembly and after the carrying straps have been adjusted correctly!

To facilitate packing and transport, the spray wand (17) and trigger handle (15) are not attached to the pressure hose (14)

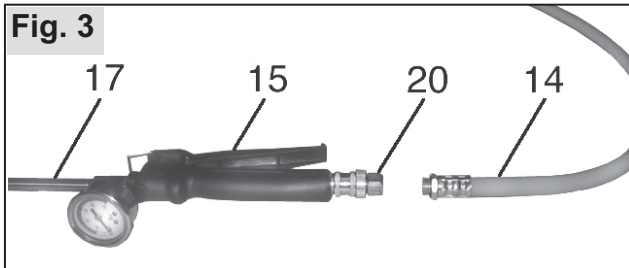

Fasten the pressure hose (14) to the trigger handle (15) by tightening the hex. Nut (20)

6. Adjusting the carrying straps



Use the sliding clips, adjust the shoulder straps to the right length.

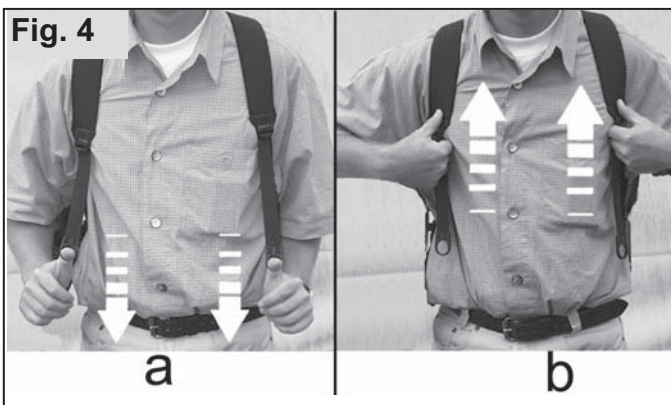

- a) Pull the loose ends of the carrying straps to tighten them.
- b) Lift up the two sliding clips again to release the straps.

When adjusting the straps, ensure that the back panel fits snugly and securely against the back of the person wearing the backpack.

7. Fuelling



Always comply carefully with the specifications in the separate operating instructions for the engine.

7.1 Model with a Honda 4-stroke engine

Unleaded normal petrol can be used as fuel. Before starting up the tool, always check that there is enough suitable engine oil in the oil tank (the dipstick is located in the oil tank cap – for further information refer to the operating instructions for the engine).

We recommend
SOLO All year 4-stroke engine oil, part no.:
0083115.

7.2 Fuelling

While fuelling always follow all safety instructions and take all safety precautions.

Handle fuel only with the engine turned off. Carefully clean the area around the filler inlet. Place the machine with the fuel inlet pointing upwards. Unscrew the tank lid and fill the fuel mixture up to the lower edge of the filler neck. Use a funnel with filter to prevent tank contamination. After filling the tank replace the tank lid and tighten firmly.

8. Prior to first use and after extended storage periods



Prior to using the engine driven high pressure sprayer for the first time and after extended storage periods we recommend that you check the correct operation of the complete machine. Also check all parts and hoses which carry fuel and chemical liquid for any leakage. This should be done before you mix the chemical solution. After reading the manual thoroughly test the machine as described in the following paragraph.

Observe all safety instructions while testing the machine.

Test run:

Fill the liquid tank with approx. 5 litres of water after carrying out a successful visual check of the machine. Fill the fuel tank with the correct fuel mixture as described in section 8 "Fuelling " and start the high pressure sprayer as described in section 11 "Starting engine / Stopping engine" for a test run. Check all parts and hoses which carry fuel or chemical liquid for leakage. Check the efficient operation of the throttle lever (8), the operating handle (15), pressure gauge (16) and the stop button (9)

Hint: To get a feel for the machine and to gain confidence in the high pressure sprayer we suggest you carry out several spray trials with water only at various pressure settings.

Note: The pressure gauge will only provide a pressure reading when the operating handle is in open position during the spraying process.

If irregularities, leakages, visual damage (even on the carrying frame), limited function or incorrect adjustments are detected, do not start any spray operations but have the high pressure sprayer checked by a specialized service centre.

9. Preparation of spray chemicals, filling of liquid container



Always observe all safety instructions and safety precautions when handling spray chemicals. Refer to the safety instructions provided in this manual, especially section 2.3 "Safe handling of spray chemicals" and the instructions provided by the chemical manufacturer

Additional basic rules for filling liquid containers

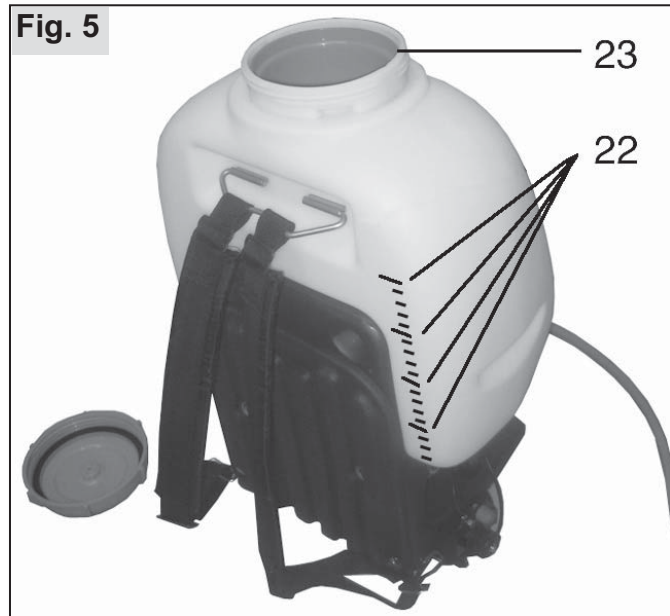

The liquid tank of the high pressure sprayer has a maximum fill capacity of 20 litres. The back of the container is marked (22) to indicate the volume of liquid in the tank. Do not fill correctly mixed spray chemicals above the upper marking (23) or the lower edge of the inlet filter (23).

The inlet filter (23) has a mesh size of 0.65 mm. The filter has to be used for the filling process. Check the filter prior to use. If the filter is damaged, replace it with the original replacement part, part number 06 10 03 926 006.

To fill and refill the spray tank stop the engine, take off the sprayer and place it on a suitable cover sheet on the ground.

Avoid contamination of water systems and drainage / rain water systems. Chemical spillages should be cleaned up immediately.

Before filling the tank ensure the trigger handle is closed and the tank drainage cap (13) is tightened firmly. Never prepare and mix spray chemicals in the chemical tank of the machine.

After filling the chemical tank with the required spray volume replace the tank lid and tighten firmly to prevent chemical leakage

Liquid volume

Prepare spray liquid according to the requirements of the chemical manufacturer. Match the spray volume to the actual requirement.

Preparation of spray chemicals

Prepare plant protection chemicals in the open air, never in living areas, stables or storage areas for food stuff or fodder.

Plant protection chemicals in powder form:

- Prepare the spray mixture in a separate container. Do not prepare the mixture in the chemical tank of the machine!
- Mix the solution well, then pour into the chemical tank of the high pressure sprayer. Use the tank inlet filter!
- Use the spray wand to stir the spray solution in the chemical tank of the machine.

Plant protection chemicals in liquid form:

- Fill chemical tank of machine $\frac{1}{4}$ with water,
- Pre-mix spray chemical with water in separate container according to the instructions of the chemical manufacturer,
- Pour pre-mixed spray chemical into the chemical tank of the high pressure sprayer. Use inlet filter.
- Add water according to the instructions of the chemical manufacturer.
- Stir the spray solution in the spray tank with the spray wand.

Biological spray solutions should be poured through a strainer before pouring the solution into the spray tank via the inlet filter. This will prevent repeated clogging of the inlet filter.



Identification of the tank contents:

Attach the relevant sticker to the spraying agent tank to indicate the contents of the tank (i.e., herbicide, fungicide or insecticide).

The designation of the spraying agent used has to be attached to the device and has to be updated every time when the spraying agent is changed.



CAUTION:

Never fill different spraying agents into the spraying agent tank without first thoroughly cleaning the tank and all parts that come into contact with the spraying agent and flushing the system with plenty of clean water.

Never use aggressive, acid- or solvent-containing cleaning agents (gasoline for example).

10. Starting / Stopping the engine



Precise details for your engine type can be found in the separate engine operating instructions.

Every time you pull the starter cord, observe the correct position and the safe position of the power tool in accordance with the following chapter 11.2 "Starting".

10.1 Preparation for starting

To prevent the pump from running dry, always fill liquid into the tank (11) before starting the machine.

When the sprayer is used for the first time or after extended storage or after the liquid tank has been completely run dry (brief dry run of the pump), the pump has to be primed. This is easily done by holding the spray wand (17) into the liquid tank or in a suitable container for spray liquid and press the operating lever (15). This will allow liquid from the tank to re-fill the pump.

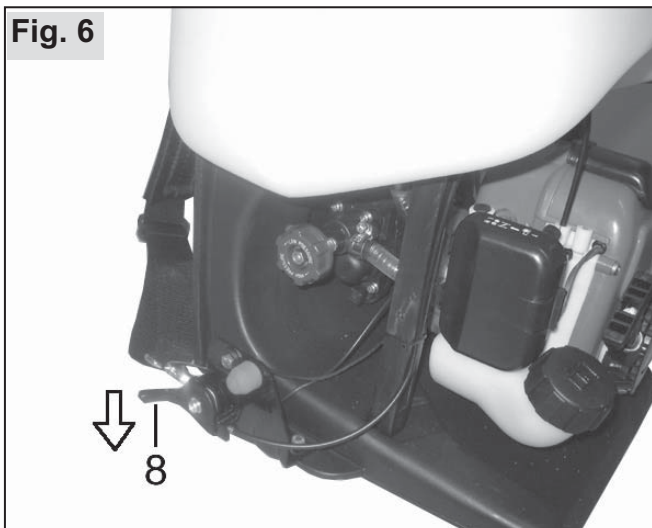

(schematic diagram / depending on the version)

Move the throttle lever (8) to idling position (down). Turn the pressure regulator (10) counter-clockwise to set a low pressure for starting.

10.2 Starting

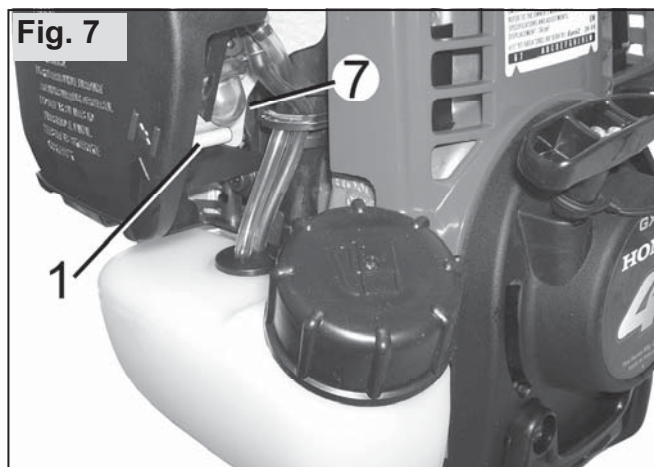

(schematic diagram / depending on the version)

When starting the engine for the first time or after the fuel tank has been run dry, press the primer bulb (7) at least five times until fuel is visible in the primer bulb.



(schematic diagram / depending on the version)

Place the high pressure sprayer on the ground. Ensure the sprayer and the person to start the machine are in a steady position. Ensure the trigger handle on the spray wand is closed and not open for continuous spraying.

Use one hand to push the machine down on the tank lid of the liquid tank. Use the other hand to slowly pull up the starter handle until resistance is felt. Then pull the starter handle quickly and forcefully in a straight line from the rope guide. Do not jam the cord on the rope guide. Avoid pulling the handle to the full length of the rope as this might cause the rope to break. Slowly guide the starter back to the starting position.

Adjust choke (1) as follows:

When the engine is cold:

With the **choke lever (1)** up (↗) start the engine by pulling the starter handle up in a straight line several times until the engine is briefly audible (ignition).

Then immediately move the **choke lever (1)** down. Continue to start until the engine runs evenly.

When the engine is warm:

With the **choke lever** down start the engine by pulling the starter handle up in a straight line several times until the engine runs evenly.

We recommend the following procedure if the engine is flooded and it is difficult to start the engine:

- Remove the spark plug and dry fuel mixture from the electrodes.
- Move the throttle lever up to full throttle. Pull the starter handle several times (with removed spark plug) to clear the combustion chamber.
- Move the throttle lever down to idling position, refit the spark plug, the plug cap and the plug cover.

After the engine runs adjust the throttle lever (8) to obtain the required engine speed. Use full throttle if the sprayer is set for high spray pressure. If lower pressures are required, only use $\frac{3}{4}$ throttle. This will save fuel. Then turn the pressure regulator (10) to set the required pressure which is indicated by the pressure gauge (16) fitted to the operating handle (15).

Also note the hints provided in section 12.2 "Pressure Regulation".

Caution:

void clutch slippage. If needed increase the engine speed with the throttle lever after setting the spray pressure with the pressure regulator.

The following hints serve to extend the service life of the starter rope and the starter mechanism:

- Always pull up the starter rope in a straight line.
- Do not let the rope rub against the edge of the rope eyelet to prevent fraying.
- Do not pull out the rope over its full length to prevent breakage.
- Guide the starter handle to its initial position rather than letting the handle slam against the starter housing.

A damaged starter rope can be replaced by a service specialist.

10.3 Stopping engine:

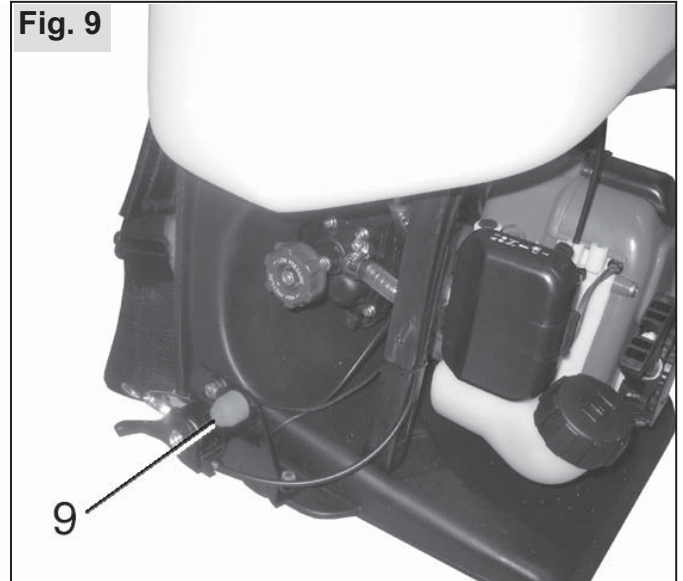

(schematic diagram / depending on the version)

Press stop button (9) until the engine stops.

11. Use of High Pressure Pump



11.1 Scope of Application

This high pressure pump is suitable for the application of approved liquid plant protection material, pesticides, herbicides and liquid fertilizers available from authorized trade outlets. We recommend to only use plant protection chemicals which have been approved by your local, regional, state or federal authorities. In Germany, the Federal Institute for Biology (BBA) is responsible for the approval of plant protection chemicals.

The areas of application for this high pressure pump are agriculture, viticulture and horticulture.

The machine is not to be used in windy and rainy conditions to prevent the spread of the spray material over a large area.

Check the wind direction prior to commencing work.

Never spray towards open doors, windows, cars, animals, children or anything that may be damaged by chemicals.

Exercise extreme caution while spraying.

Generally there is less wind and air movement during early morning and early evening hours. It is recommended to spray during that time. Only wet those plants and objects which are targeted. In any case we recommend caution during the spray operation

11.2 Pressure Regulation

A certain spray pressure has to be maintained depending on nozzle adjustment, nozzle type, type of spray chemical, walking speed etc. The pressure should be even and continuous. A pressure gauge (16) fitted to the trigger handle (15) indicates the pressure in the liquid delivery system.

Note: The pressure gauge only shows the pressure while liquid is flowing through the pressure handle during actual spray operation

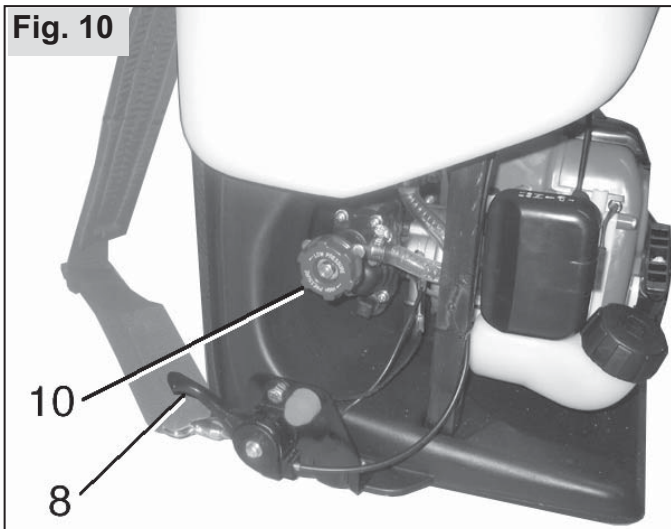

(schematic diagram / depending on the version)

Spray pressure can be altered by:

- Changing the engine speed via the throttle adjustment lever (8)
 - Lower engine speed → lower pressure

For high pressure set the throttle lever to full throttle. For lower pressure adjust to $\frac{3}{4}$ throttle. This will save fuel.
- Adjustment to Pressure Regulator (10)
 - Turn clockwise to the right → increased pressure,
 - turn anti-clockwise to the left → lower pressure.

Spray pressure should not exceed 30 bar. (Red field on pressure gauge).

Hint:

While the engine is running, leave the spray pressure set at low while using the throttle to achieve the required engine speed. Then turn the pressure regulator (10) to adjust to the required pressure. This way the engine does not have to work against high pump pressure during the transition from idling speed to operating speed.

Caution:

Avoid clutch slippage. If needed increase the engine speed with the throttle lever after adjusting the spray pressure with the pressure regulator. Never operate the engine for longer periods with the pressure handle in the CLOSED position. This applies particularly when high spray pressure has been selected.

11.3 Spray nozzle / Output volume

Fig. 11



A double nozzle (18) is supplied as standard equipment with the sprayer.

The following general output data is valid for this nozzle:

| Spray Pressure in bar | Output volume in l/min |
|-----------------------|------------------------|
| 5 | 0.92 |
| 10 | 1.28 |
| 20 | 2.00 |
| 30 | 2.88 |

11.4 Excess spray chemical / Completing spraying operation

Stop the engine of the high pressure sprayer as soon as air is pumped through the nozzle (this can be heard and seen by the formation of fog like spray drift). At that point the remaining spray chemical in the tank is less than 200 ml. Unless you want to refill the tank and continue with the spray operation, dilute the remaining spray volume with 2 litres of water. Apply the dilution over the already treated area.

Never operate the engine without liquid in the spray tank. The pump will suffer damage if operated dry.

After finishing the spray operation, stop the engine by pressing the stop button (9) until the engine stops. Let the engine cool down. Empty and clean the machine according to section 13.4 "Emptying and cleaning of chemical tank". Thoroughly wash face and hands with water and soap. Remove the work clothing after spraying. Clean work clothing regularly.

Note:

After extended operating periods of the high pressure sprayer, the engine and some parts (such as the muffler) around the engine can get very hot. To prevent any consequential damage we recommend the running of the engine at idling speed for a short time after the engine has been used at full speed for longer periods before the engine is shut down as described.

11.5 Spray tube holder

Fig. 11

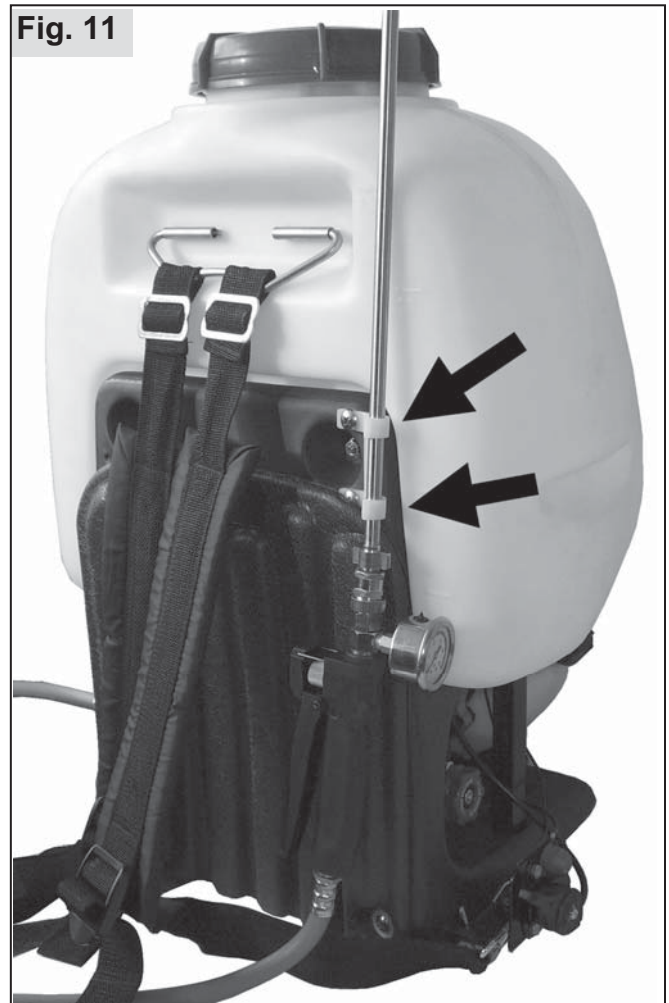

12. Operating and maintenance instructions



12.1 General operating and maintenance instructions

The maintenance and the repair of modern machines as well as their safety-relevant assemblies require qualified specialised training and a workshop equipped with special tools and test equipment. Consequently the manufacturer recommends that all tasks not described in these operating instructions be carried out by a specialised workshop. That specialist has the required training, experience, and equipment at his disposal, to provide you with the most cost-effective solution for such work. He will provide additional help in word and deed.

After a running-in time of app. 5 hours, all accessible screws and nuts (except the carburettor adjusting screws) must be checked for tightness and they must be retightened, if required.

Always check the engine driven high pressure pump prior to commencing work to ensure the complete machine is in good and safe working order.

It is best to store the equipment in a dry, safe location with a full fuel tank. There should be no open flame or similar nearby. When not using the equipment for longer periods, (longer than four weeks), see chapter "13.5 Shutdown and storage".

12.2 Engine components

When performing adjustments or maintenance work on engine components, always carefully follow the specifications in the separate operating instructions for the engine. Only perform work which is actually described in the instructions and which you feel able to carry out. All other work must only be performed by an authorised specialist workshop, who will also be happy to assist with any queries.

The following work is the minimum level of work which must be performed on a regular basis in accordance with the specifications in the operating instructions for the engine:

- Check the idling position and readjust the idling stop screw as required.
No drive must be delivered to the cutting tool when the engine is idling.
- Clean the air filter and check the filter element.
- Check the silencer **before** starting work and **before** starting the engine to check it is in perfect condition.
Never touch the silencer when it is hot.

- Check the spark plug to make sure that the electrode gap is correct and the electrodes are not excessively burned off.
- Check the fuel tank breather and the fuel filter.

12.3 Checking output volume of spray chemical

Check the output volume of the machine (l/min) to ensure the measured data agrees with the spray volume stated in section 12.3 "Spray nozzle / Output volume". This should be done at least once per year, preferably at the beginning of the spray season.

Fill the liquid tank with water to the maximum fill mark on the tank. Operate the sprayer for exactly one minute at 10 bar pressure.

Stop the engine and measure the volume of water required to refill to the max. fill mark.

The measured volume is the output of the machine in l/min at 10 bar operating pressure. The ascertained data should not vary by more than 10% from the data provided in section 12.3 "Spray nozzle / Output volume".

If the measured volume is too small, the nozzle may be partially blocked. Clean the nozzle and repeat the test procedure.

If the measured volume is too large, the nozzle may be damaged or worn. Replace the old nozzle with a new nozzle

While checking the output volume also check the nozzle for even output over the full spray pattern.

12.4 Emptying and cleaning liquid tank



(schematic diagram / depending on the version)

To clean the liquid tank drain all residual chemicals via the drain plug (13) in a suitable container. If required, tilt the machine slightly to the side to ensure complete drainage of any remaining chemical solution. Before tilting the machine, ensure the fuel tank lid is tight and all fuel hoses and parts connected with the fuel system cannot leak fuel. The engine should have cooled down. Ensure the liquid will not drain over machine, especially the engine, but directly in a suitable container.

Drain and thoroughly rinse the liquid tank daily after use with fresh water. Observe any cleaning hints provided in the instructions supplied with the chemical. After cleaning, leave the tank to dry with the tank lid open.

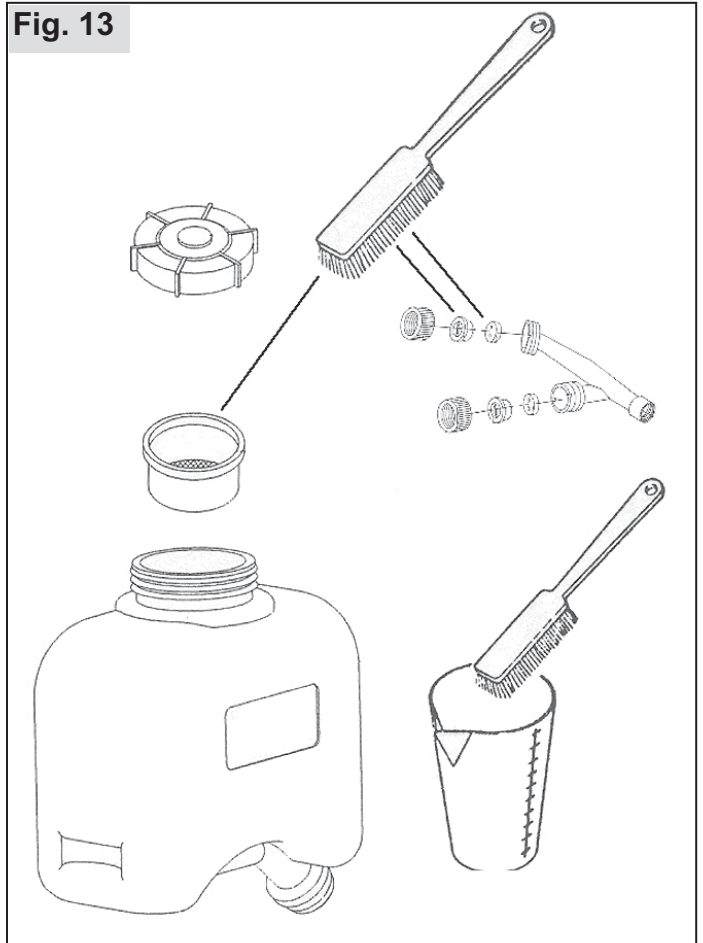

Regularly clean the inlet funnel filter and the spray nozzle with a soft brush. Never use the mouth to blow through the nozzle!

12.5 Shutdown and storage

Drain and clean the machine according to the instructions provided in section 13.4 "Emptying and cleaning liquid tank".

Never use aggressive cleaning solutions or those containing solvents to clean any part of the engine. Never hose down the engine. For best results, simply wipe down the entire engine with a dry or slightly damp cloth.

Store the device in a dry, safe location inside a building (garage, basement, ...). There must not be any open fires or similar nearby. Ensure that the device cannot be used by unauthorised persons, especially children.

If not in use for more than four weeks, drain the fuel tank in a well ventilated location before storing. Start the engine with an empty fuel tank and drain the carburettor until the engine stops.

12.6 Scheduled maintenance



The following information is based on standard operating conditions. For special conditions, such as prolonged daily use, the recommended maintenance intervals should be reduced accordingly.

Implement all maintenance jobs regularly. If required, authorise a specialist service centre to maintain the machine for you. The owner of the machine is responsible for:

- Any damage caused by a lack of maintenance, incorrect or late maintenance and repairs
- Consequential losses - including corrosion - from incorrect storage

| | | after the first 5 hours | daily | weekly | after every 50 hours | after every 100 hours | as required | before spray season |
|--|--|-------------------------|-------|--------|----------------------|-----------------------|-------------|---------------------|
| Air filter | Clean | | X | | | | | |
| | Replace | | | | | | X | |
| Spark plug | Check electrode gap and replace spark plug if required | | | | X | | | X |
| | Replace | | | | | X | X | |
| All accessible screws (except for adjusting screws) | Retighten | X | | | | | X | X |
| Operating controls (Stop-button, throttle lever, operating handle, pressure regulator) | Check function | | X | | | | | |
| Exhaust | Visual check | | X | | | | | |
| Spray output volume and distribution | Check | | | | | | | X |
| Liquid tank | Empty and clean | | X | | | | | |
| Liquid tank inlet filter | Clean | | | | | | X | X |
| Spray nozzle | Clean | | | | | | X | X |
| Liquid or fuel leaks | Check | | X | | | | | |
| Complete machine | Visual check | | X | | | | | |
| | Test run with water | | | | | | | X |
| | Clean | | | | | | X | X |

Furthermore, as part of the annual service at an authorised dealer, request the following services:

- Complete check of the entire machine
- Professional cleaning of the engine (fuel tank, cylinder head fins, ...)
- Check and, if necessary, replace wearing parts, particularly the annual fuel filter change
- Optimum setting of the carburettor

13. Technical Specifications

Engine type and specification → please read the separate operating instructions for the engine

| | | |
|--|---------------------------|--|
| Capacity of liquid tank | l | 23 |
| Nominal volume | l | 20 |
| Mesh size liquid inlet filter / nozzle filter element | mm | 0.65 / 0,55 |
| Residual liquid volume in tank after machine stops regular spray output | ml | < 200 |
| Medium idling speed | rpm | 3100 ± 200 |
| Permissible speed | rpm | 9500 ± 200 [5 bar] 8000 ± 200 [30 bar] |
| Operating pressure | bar | 5 - 30 |
| Output volume with standard nozzle | l/min | |
| at 5 bar operating pressure | | 0.92 |
| at 10 bar operating pressure | | 1.28 |
| at 20 bar operating pressure | | 2.00 |
| at 30 bar operating pressure | | 2.88 |
| Spray Wand | Material | Steel tube |
| | Length in mm | 500 |
| Spray hose | Length in mm | 1500 |
| | Pressure resistant to bar | > 50 |
| Spray nozzle, standard | | Double flat spray |
| Sound pressure level L_P to EN ISO 11200 | dB(A) | 82 ± 2.5 dB(A) |
| Sound pressure level L_W to EN ISO 3744 | dB(A) | 95 ± 2.5 dB(A) |
| Weighted average of acceleration to ISO 7916 handle at max. engine speed | m/s ² | < 2.0 ± 1m/s ² |
| Weight | m_{net} kg | 9.8 |
| | m_{total} kg | 30.4 |
| Dimensions without spray wand and spray hose | mm | Height: 630 / Width: 440 / Depth: 350 |

14. Guarantee

The manufacturer guarantees problem free quality and will cover the cost of replacing parts which are found to be faulty in material or show manufacturing defects within the prescribed guarantee period after the date of purchase. Please note that specific guarantee conditions may differ from country to country. When in doubt, please ask the vendor of the goods. The vendor of the product is responsible for guarantee applications.

We hope you will understand that we cannot be liable for damage resulting from these causes:

- Non-compliance with operating instructions.
- Neglecting required maintenance and repair jobs.
- Damage caused by improper carburettor adjustment.
- Wear from normal use.
- Obvious overload by continuously exceeding the upper performance limit of the product.
- Using non-approved tools.
- Use of force, improper treatment, misuse and accidents.
- Damage from excessive heat due to dirt build up around the cooling fan housing.
- Attempted adjustments and repairs by non-qualified persons.
- Use of unsuitable spare parts or non-original parts if such parts are the cause of the damage.
- Use of unsuitable or stale fuel.
- Damage caused by using the product in the hire or rental industry.

Normal cleaning, adjustments or maintenance jobs cannot be claimed as part of the guarantee. All guarantee work must be carried out by a service centre authorized by the manufacturer.

solo[®]



SOLO Kleinmotoren GmbH

Industriestraße 9 D-71069 Sindelfingen

Postfach / PO Box 60 01 52 D-71050 Sindelfingen

DEUTSCHLAND / GERMANY

Tel.: +49 (0)7031 301-0 Fax: +49 (0)7031 301-202

info@solo-germany.com <http://solo.global/>