

solo[®]

453

*Translation of the original
instructions
Instruction manual*

Pressure Sprayer



Attention!

Read this instruction manual carefully before first operation and strictly observe the safety regulations!



ENGLISH

- 1 Spray tube
- 2 Pressure relief valve
- 3 Pump handle
- 4 Spray nozzle
- 5 Shut-off valve
- 6 Spraying agent tank
- 7 Transport handle
- 8 Handle screwing
- 9 Month and year of production (back side of the container)
- 10 Holding clamp

Fig. 1

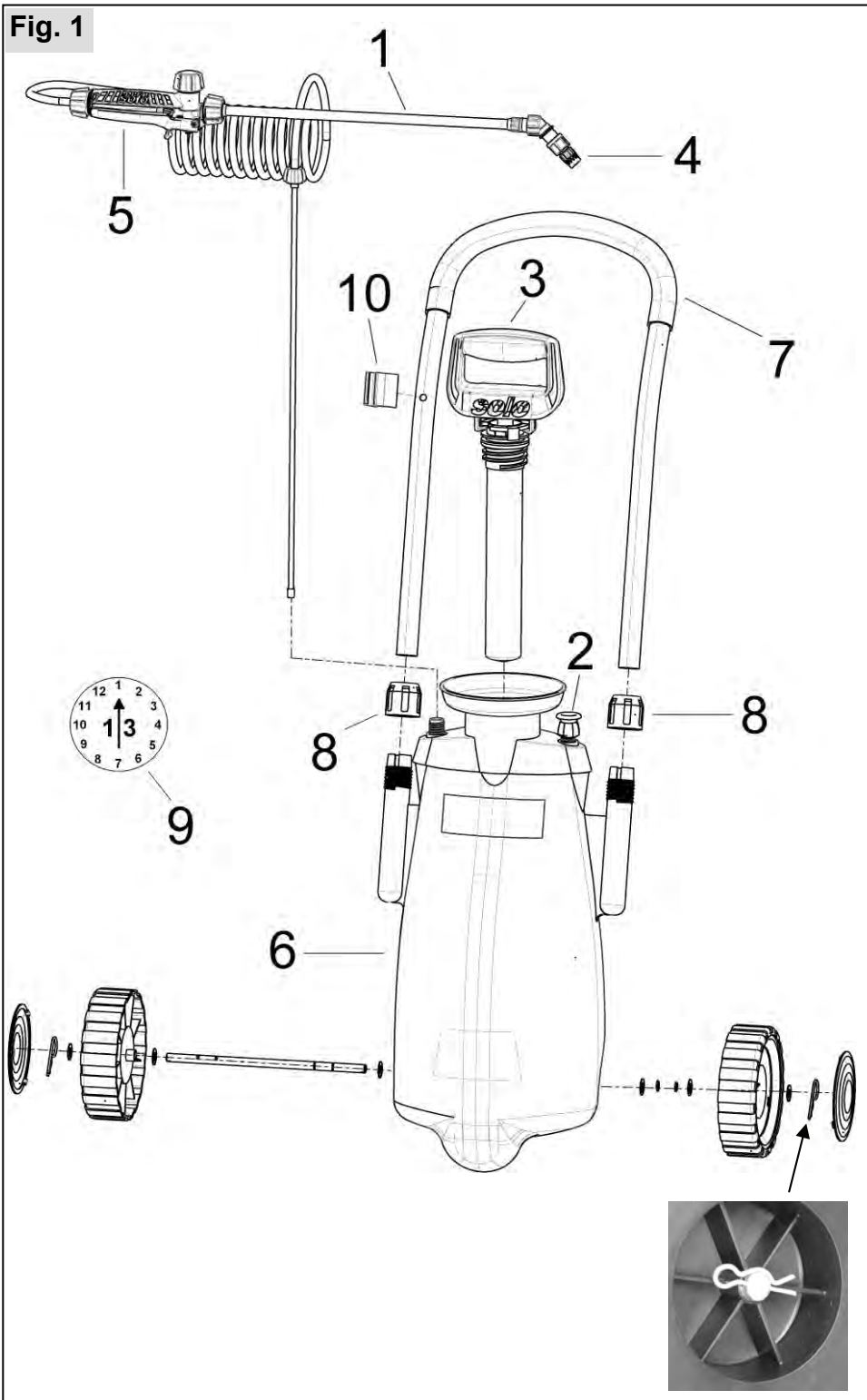

Fig. 2 16 x 3 mm

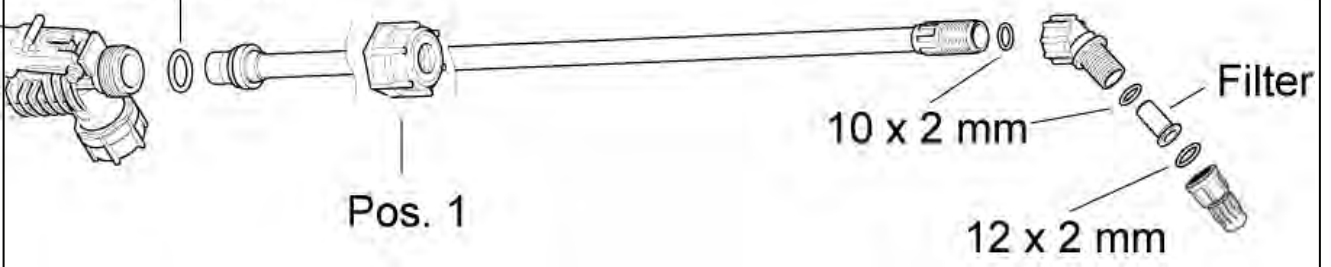

Fig. 3



Fig. 4



Fig. 5



Fig. 6



Fig. 7



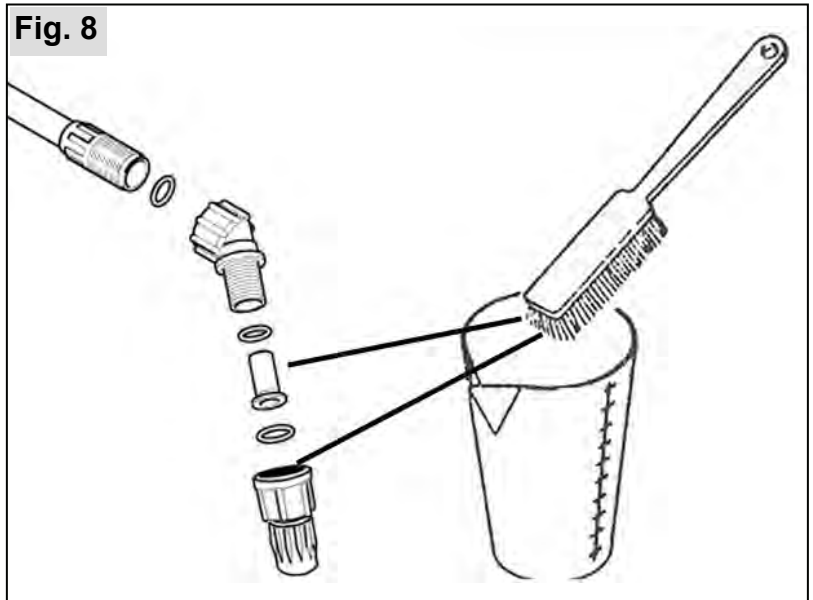

Fig. 8



Instruction manual

Translation of the original instructions

  **Caution!** Prior to operating the unit, please read this instruction manual carefully, and most importantly, observe all safety rules.

To ensure that your device will continue to work properly and deliver optimum performance for many years to come, ensure that you follow all operating and maintenance instructions.

Your authorised SOLO dealer will be glad to assist you with any questions.

Packaging and disposal

Please keep the original packaging in order to protect the equipment against transport damage in case you ever need to ship it or transport it. If the packaging materials are no longer required then they must be disposed of properly in accordance with applicable local regulations. Cardboard packaging materials are raw materials which can be recycled or reused.

At the end of the equipment's service life, please make sure that you dispose of it properly in accordance with the official directives and regulations that apply in your area.

In the best interest of continued technological progress we reserve the right to change the design and configuration of any product without prior notice.

For that reason, no claims can be accepted with reference to text and illustrations in this manual.

Symbols

The following symbols are used in this instruction manual and on the device itself:



Read the manual carefully.



DANGER! Failure to comply with the instructions could cause accidents with potentially life-threatening injuries.



Wear the prescribed protective clothing.



Wear protective gloves.



Wear face protection (e.g., safety goggles).



Wear breathing mask.



Smoking prohibited.



No naked flames.



Minimum distance to bystanders: 15 m (approx. 16 yards)



Year / month of production



Recycling code for the material of the spraying agent tank (PE-HD).

Table of contents



1 Safety regulations	3
1.1 <i>Correct use / areas of application</i>	3
1.2 <i>General safety instructions</i>	4
1.3 <i>Safe handling of spraying agents</i>	4
1.4 <i>Work clothing / personal protection equipment (PPE)</i>	5
1.5 <i>Transportation of the device</i>	5
1.6 <i>Before and during work</i>	5
1.7 <i>Maintenance, repairs and storage</i>	6
2 Preparing the device for use	6
2.1 <i>Assembly</i>	6
2.2 <i>Spray nozzle and filter element</i>	6
2.3 <i>Height adjustment of the transport handle</i>	6
2.4 <i>Trial run</i>	6
3 Mixing spraying agents and filling the spraying agent tank	6
4 Using the pressure sprayer	7
4.1 <i>Spraying</i>	7
4.2 <i>Transport of the pressure sprayer</i>	8
4.3 <i>Residual spraying agents / finishing spraying</i>	8
5 Maintenance, cleaning and storage	8
5.1 <i>Trial run</i>	8
5.2 <i>Checking the spray nozzles and the filter element by measuring the spraying agent delivery rate</i>	9
5.3 <i>Changing the spray nozzle and the filter element</i>	9
5.4 <i>Greasing the pump gasket</i>	9
5.5 <i>Draining the spraying agent tank and cleaning the spraying agent carrying parts</i>	9
5.6 <i>Taking the sprayer out of service and putting it into storage</i>	9
5.7 <i>Maintenance plan</i>	10
6 Standard delivery	10
7 Specification and special accessories	11
8 Wearing parts	11
9 Warranty	11

1 Safety regulations

1.1 *Correct use / areas of application*

- This pressure sprayer must only be used for the purpose of applying approved liquid plant protection agents, pesticides, insecticides, weed killer (herbicides) and liquid fertilizers available from authorised specialist dealers as well as for the purpose of applying clean water.
- Observe all instructions provided by the spraying agent manufacturer.
- We recommend using only spraying agents that have been approved for use as spraying agent for the above mentioned areas of application by the relevant authorities in your country.
- Never use fluids with a temperature in excess of 40 °C [104 °F].
- The pressure sprayer must only be used for applications in agriculture, tree nurseries, forestry, fruit and vegetable growing, vineyards, home and garden and greenhouse cultivation with adequate ventilation.
- The pressure sprayer must not be used for any other purposes, e.g., for the spraying of liquid paint or applying any other media than the above mentioned liquids!
Particularly, aggressive, acid- or solvent-containing liquids, disinfectants or impregnating agents must not be sprayed with this device!
- To enable the operator in connection with the spraying agent manufacturer to check the material resistance to certain chemicals, we will provide details of the type of materials used for the pressure sprayer.

1.2 General safety instructions

  Please take the time to carefully read through these operating instructions before using the device for the first time and keep them in a safe place thereafter. Always take great care when using the device.

You can put your life at risk by failing to follow the safety instructions.

It is also important to follow any relevant health and safety regulations that apply to your place of work.

Anyone who fails to follow the safety instructions, operating instructions or maintenance instructions will make themselves liable for any damage and consequential damage caused as a result.

The operating instructions must be kept available at all times wherever the device is used or stored. They must be read by anyone instructed to use the equipment or perform work with or on the device (including servicing, maintenance and repairs).

- A first time operator should obtain practical instruction by an authorised SOLO dealer before using the equipment.
- Persons under the age of 18 are only permitted to use this plant protection device under supervision.
- Keep persons and animals away from areas in which you are working. Never spray in the direction of other persons, animals or objects that could be damaged as a result. Bear in mind that the liquid emerges at high speed from the spray nozzle. Objects could be kicked up as a result, and this could in some cases represent a risk. The user is responsible for any hazards or accidents involving other persons and/or their property.
- This equipment must only be hired out, lent or passed on to persons who are familiar with this type of equipment and its operation and who have read the operating instructions. Always ensure that you hand over the operating instructions together with the device.
- Ensure that you are in good shape, well rested and healthy when using this device. Do not use this device, if you are tired or sick.
- Never use this device under the influence of alcohol, drugs or medication that could impair your reaction speed.
- Never alter, change or modify any safety equipment or operating controls.
- Never use the device if any part of it is unsafe or if it is not in an overall condition that makes it safe to use. Before using the device always check whether it is safe to use according to section 5.7.
- Immediately replace damaged parts. Only use genuine SOLO replacement parts.

- Only use accessories and add-on parts that have been supplied and specifically approved for installation on the device by us.
- The quality of any spare parts used is also an important factor in ensuring that your device is reliable and safe to use. Always use genuine SOLO replacement parts, as these are the only parts that have been manufactured with the same equipment and under the same conditions as the parts originally fitted to the device. This ensures the highest possible level of quality and accuracy of fit – vital factors in ensuring the safety, reliability and proper functioning of your device. Genuine SOLO replacement parts and accessories are available from your authorised SOLO dealer. He also has access to the necessary spare parts lists, from which the required part numbers can be taken, and he will also be kept up to date about any minor improvements and changes to the range of parts on offer.

Please note that the use of non-genuine replacement parts will invalidate your warranty.

- When the device is not being used it should be safely stored in a place where it will not endanger the health and safety of others. Prepare the device for storage according to section 5.5. Ensure that the device is stored in a safe place where unauthorised persons cannot access it.

1.3 Safe handling of spraying agents



- Avoid contaminating the environment, the mains water supply and/or public sewer systems with spraying agent or cleaner! Ensure to avoid contamination when mixing, filling, using, draining, cleaning, servicing and transporting by using adequate procedures and suitable containers.
- Spraying agents and cleaners must never be allowed to enter the mains water supply – not even by back-suction when filling, public sewer systems, sprayed onto wastelands, allowed to drain into natural bodies of water or disposed of together with normal domestic waste. This also means that appropriate care must be taken during filling to ensure that none of the spraying agent is drawn back into water pipes. Spraying agents and cleaners and any unused leftovers of spraying agents and cleaners must always be collected in a suitable container and disposed of via approved facilities for household chemical waste. Please contact your local authorities for information about your nearest disposal facilities.
- Avoid any direct contact with spraying agents. In case of contact with health hazardous spraying agents, immediately rinse the affected body parts with plenty of clean water, immediately change the clothing soaked with spraying agents and immediately seek medical advice.

- Never eat or drink when handling spraying agents.
- Stop working immediately if you start to feel unwell while working, or if you become unusually tired. Seek medical advice if the condition persists.
- Never allow children or anybody who is not familiar with handling this type of spraying agent to handle the spraying agent.
- Clean the spraying agent tank and all other spraying agent carrying parts whenever the spraying agent is changed. To flush out any residue from the pump and the hose, run the pressure sprayer with clean water after cleaning the spraying agent tank and before the next spraying agent is filled in. This will prevent the risk of any chemical reactions taking place between the different substances.
- Never spray in narrow or enclosed spaces – spraying agents are toxic and there is a risk of poisoning. Spraying equipment must for example only be used in greenhouses if adequate ventilation is provided. Signs must be put up in greenhouses that have been treated. Nobody should enter the greenhouse again until it has been thoroughly ventilated.
- When you have finished spraying, prepare the device for storage according to section 5.5, thoroughly wash your face and hands with soap, take off your work clothing and ensure that it is washed regularly. Any unused spraying agent that is left over in the device could cause corrosion and hence damage the device. Special attention must be paid to wearing parts like spray nozzles, filters and seals.

1.4 Work clothing / personal protection equipment (PPE)



Always wear suitable protective clothing in accordance with the relevant regulations. The clothing must protect all parts of your body against contact with spraying agents and against objects that are kicked up – i.e., protective gloves, face protection (e.g., protective goggles), protective footwear, body protection (e.g., rubber apron), if required breathing protection.

- Clothing should be appropriate – i.e., tight-fitting, but not obstructive.
-  Wear protective gloves with non-slip palms.
-  Wear face protection (e.g., safety goggles) against the spraying agents.
-  Always wear a breathing mask when working in dense and tall plants, in greenhouses, in dips in the ground or in trenches and when using dangerous spraying agents.

- Wear protective shoes with good grip, preferably safety shoes.
- Immediately change any clothing that becomes soaked with the spraying agent.
- Wash the work clothing regularly.
- Never wear a scarf, tie, loose jewellery or other items of clothing that could be caught in a bush or on a branch.

1.5 Transportation of the device

- To prevent damage and to eliminate potential hazards for other road users, use secure lashing equipment to secure the device and prevent it from tipping over, rolling away and falling when transporting it on a vehicle.
- Take appropriate measures to ensure that the spraying agent cannot leak or spill. Check the spraying agent tank and all hoses and pipes that carry the spraying agent for leaks. Before transporting the device you should ideally prepare the device for transportation according to section 5.5.

1.6 Before and during work

- Every time before you start using the device, check the entire device to ensure it is safe to use according to section 5.7.
- Check the spraying agent tank and all hoses and pipes that carry the spraying agent for leaks.
- Prior to every use, ensure the proper functioning for the pressure relief valve (2).
- Never start working if there are any irregularities or leaks, if you can see any damage to the equipment or if the equipment is not working properly in any way. In this event, immediately depressurise the device by pulling on the pressure relief valve (Fig. 4) and have it checked by a specialist workshop. Before pulling on the pressure relief valve (2), the device must always be in an upright position. Attention: Keep the device away from your face!
 -  The device must only be operated by one person at a time. Nobody else must be within a radius of 15 metres [approx. 16 yards] at the same time.
- When starting to pump, ensure that the shut-off valve is closed. Point the spray tube towards a free area.
- Always ensure that there is an adequate air change when working in restricted conditions, in tight, tall plant growth, in greenhouses, in dips in the ground or in trenches.
- Always remain within calling distance of other persons who could help in the event of an emergency.
- Take breaks at regular intervals.
- Never eat or drink when using spraying agents.

-  Never smoke in areas where you are working.
- When removing the spray tube, do not point to yourself or other persons with the end of the tube.

1.7 Maintenance, repairs and storage

Only perform maintenance work and repairs by yourself if they are covered in these operating instructions. All other work must be carried out by an authorised workshop.

The repair of modern devices and their safety-relevant assemblies, requires qualified, specialized training and a workshop equipped with special tools and test devices. The specialist has the required training, experience, and equipment at his disposal to provide you with the most cost-effective solution and can help you in many ways with advice and service.

-  The device must not be serviced, repaired or kept in the vicinity of naked flames.
- Before doing any maintenance work or repairs and before opening the spraying agent tank, depressurise the device by pulling on the pressure relief valve (Fig. 4).
Before pulling on the pressure relief valve (2), the device must always be in an upright position. Attention: Keep the device away from your face!
- Always depressurise the device by pulling on the pressure relief valve (2) before unscrewing the high-pressure hose, the shut-off valve (5), the pressure gauge (depending on the model), the spray tube (1) and the nozzle attachment (4).
- All repairs must only be performed using SOLO genuine replacement parts.
- The device must not be altered in any way, as this could adversely affect the safety of the device and potentially cause an accident or injury.

2 Preparing the device for use

2.1 Assembly

The pressure sprayer is dismantled before it is dispatched. It must be fully reassembled again before it is used.

Installation of the spray tube (1):

- Fasten the threaded collar (Fig. 2, pos. 1) on straight and firmly screw the spray tube with O-ring (16x3 mm) hand-tight onto the shut-off valve. Do not use any tools!

When your work is completed, the spray tube should be fitted into the holding clamp (10) at the transport handle (7) (Fig. 3).

Installation of the pressure gauge (depending on the model):

- Unscrew the black threaded collar from the shut-off valve.
- Screw the black threaded collar of the pressure gauge accessory kit onto the shut-off valve.
- Insert the O-ring into the threaded collar and screw the pressure gauge hand-tight into the threaded collar. Do not use any tools!

2.2 Spray nozzle and filter element

At the factory, an adjustable spray nozzle is assembled as the standard spray nozzle.

Delivery rate: See section 4.1

A filter element is fitted in the elbow piece upstream of the spray nozzle (Fig. 2).

Only the above mentioned standard spray nozzle (part no.: 49 00 525), the spray nozzles from the nozzle kit (part no.: 49 00 574) and the genuine filter element (part no.: 40 74 922 25, mesh aperture: 0.8 mm [0.031"]) must be used in this pressure sprayer. Changing spray nozzle and filter element: See section 5.3

2.3 Height adjustment of the transport handle

In order to allow different sized people back-friendly working, the height of the transport handle is adjustable.

Height adjustment of the transport handle (7):

- Unscrew the handle screwing (8) by turning it to the left (counterclockwise).
- Pull out the transport handle on both sides evenly until the desired height is set.
- Re-tighten the handle screwing by turning it to the right (clockwise).

2.4 Trial run

At the first start-up, at the start of the spraying season and in frequent use at least once a month, perform a trial run according to section 5.1 to check the entire device.

3 Mixing spraying agents and filling the spraying agent tank



When handling the spraying agents, always follow the safety instructions of these operating instructions (pay special attention to section 1.3) and the information provided by the manufacturer of the particular spraying agent. Before opening the spraying agent tank, depressurise the device by pulling on the pressure relief valve (Fig. 4). Before pulling on the pressure relief valve (2), the device must always be in an upright position. Attention: Keep the device away from your face!

Spraying agent volume:

Mix the spraying agents according to the instructions provided by the manufacturer of the spraying agent. Choose the appropriate volume according to requirements.

Mixing spraying agents:

Only mix spraying agents out in the open. Never do this inside living spaces, stables or in storage spaces that are used for food or animal feed.

Never mix the spraying agent directly in the spraying agent tank.

Spraying agents in powder form:

- Mix the spraying agent in a separate container, not in the spraying agent tank.
- Ensure that the mixture is thoroughly mixed before pouring it into the spraying agent tank.
- Use the spray tube to thoroughly mix the spraying agent in the tank.

Liquid spraying agents:

- Fill 1/4 of the spraying agent tank with clean water.
- Then pre-mix the spraying agent with clean water in a separate container according to the instructions provided by the manufacturer of the spraying agent.
- Pour the pre-mixed spraying agent into the spraying agent tank.
- Top up with the required amount of clean water according to the manufacturer's instructions.
- Use the spray tube to thoroughly mix the spraying agent in the tank.

When using spraying agents that have been mixed from herbal preparations, the liquid needs to be pre-filtered.

Filling the spraying agent tank:

To fill the tank with spraying agent, remove the pump by pushing the pump handle (3) down and turning it to the left (counterclockwise) until the handle clicks into position.

Unscrew the pump by turning it counterclockwise (Fig. 5). Do not use any tools!

Avoid any direct contact of the filling hose and the contents of the spraying agent tank.

Fill level markings are applied to the side of the spraying agent tank (6).

When filling up the tank, ensure that you do not fill above the top marking (maximum fill volume).

Maximum fill volume: 11.0 l [2.9 gal]

Never allow the spraying agent tank to overflow or public bodies of water, rainwater drains or sewage drains to become contaminated.

Immediately wipe up any spilled spraying agent.

After filling, insert the pump again and refasten firmly by turning the pump handle (3) clockwise to prevent the spraying agent from escaping. Refasten firmly until the pump handle clicks into position.

Identification of the tank contents:

The designation of the spraying agent used has to be attached to the device and has to be updated every time when the spraying agent is changed.

**CAUTION:**

Never fill different spraying agents into the spraying agent tank without first thoroughly cleaning the tank and all parts that come into contact with the spraying agent and flushing the system with plenty of clean water.

Recommendation: Use the special SOLO cleaner for plant protection sprayers (dosing bottle of 500 ml [approx. 16.9 oz], part no.: 49 00 600).

Never use aggressive, acid- or solvent-containing cleaning agents (gasoline for example).

4 Using the pressure sprayer



Ensure that you follow all of the safety instructions when using the pressure sprayer.

Every time you use the pressure sprayer, first check it all over to ensure it is safe to use according to section 5.7.

4.1 Spraying

- When applying spraying agent, ensure by using appropriate measures and procedures that the unintended release of agent to other areas is minimized and the drift to the surrounding areas is prevented.
- Always proceed with the greatest care when spraying.
- Never use the device under windy conditions or if it is raining, as this would risk widespread drifting of the spraying agent.
- Check the wind direction before starting work and select the spraying direction downwind of the user.
- It is best to perform spraying work in the morning or evening, as it tends to be less windy then.
- Ensure that you only wet what is in fact intended to be covered with spraying agents.
- Never spray the agent towards persons, animals, open windows or doors, cars or anything else that could be damaged by the spraying agent.
- When spraying, ensure that the spraying agent is applied evenly and homogeneously to the treated area.

Pumping and spraying:

To pump, loosen the pump handle (3) by turning out of the stop position. Pump the unit until the operating pressure is reached in the spraying agent tank (Fig. 6). Excessive pressure escapes automatically through the pressure relief valve (2).

Hold the spray tube at the shut-off valve in your hand.

Start the spraying process by pressing the shut-off valve (5).

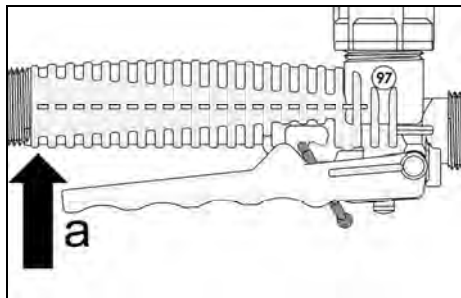

Releasing the shut-off valve stops the spray process.

The red clip can be used to secure the shut-off valve in its rest position to prevent accidental spraying. For this, pull the lever slightly away (a) from the handle and lock the clip (b).

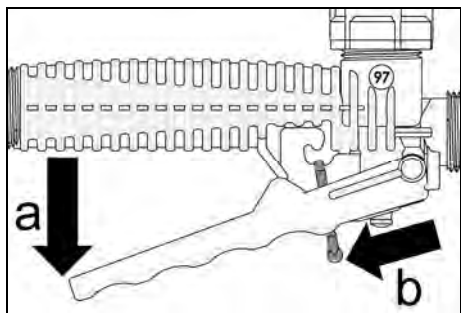
**Nozzle adjustment (Fig. 7):**

Nozzle closed

→ hollow cone

Delivery rate at 2 bar:

0.45 l/min [0.119 USgal/min]

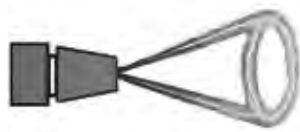

Nozzle open

(max. 1 turn, 360°)

→ coarse and narrow jet

Delivery rate at 2 bar:

0.70 l/min [0.185 USgal/min]



The spray tube (1) can be rotated in the shut-off valve (5) – after loosening the threaded collar (Fig. 2, pos. 1) – this is useful for spraying under leaves.

If the spraying agent is not applied properly, spray nozzle or filter element could be blocked or damaged. If necessary, clean or replace the nozzle and the filter element.

Cleaning: See section 5.5

Replacing the spray nozzle and the filter element: See section 5.3

4.2 Transport of the pressure sprayer

The device can also be carried by the pump handle (3), if the pump handle is pressed down completely, and it is turned to the right and clicked into position.

To avoid damage to the spraying agent tank during rolling transport of the device, always tilt the device so far back that the spraying agent tank doesn't touch the ground.

4.3 Residual spraying agents / finishing spraying

Stop spraying immediately when any air is sucked in and sprayed out through the spray nozzle. This is indicated by a mist being sprayed from the nozzle. At this point the spraying agent tank will still contain a residual amount of less than 250 ml [8.5 oz].

If you do not want to add more spraying agent and wish to stop spraying instead, dilute this leftover amount with 2.5 litres [85 oz] of clean water and spray it on the treated area.

When you finish working, prepare the device for storage according to section 5.5, thoroughly wash your face and hands with soap, take off your work clothing and ensure that it is washed regularly.

5 Maintenance, cleaning and storage**5.1 Trial run**

At least at the start of every spraying season and in frequent use at least once a month, perform a trial run with clean water to check the following:

- Tightness of all equipment components at maximum permissible pressure with open and closed shut-off valve
- Function of all active components (pressure relief valve, shut-off valve, pump handle, pressure gauge (depending on the model))
- Dosing and distribution accuracy of the nozzle used by measuring the spraying agent delivery rate according to section 5.2

Never start working if there are any irregularities or leaks, if you can see any damage to the equipment or if the equipment is not working properly in any way. In this event, immediately depressurise the device by pulling on the pressure relief valve (Fig. 4) and have it checked by a specialist workshop.

Before pulling on the pressure relief valve (2), the device must always be in an upright position. Attention: Keep the device away from your face!

5.2 Checking the spray nozzles and the filter element by measuring the spraying agent delivery rate

Fill up the tank with clean water to the maximum marking, start it up and spray for exactly one minute at an operating pressure of 1 bar. Then measure the quantity of water required to refill the tank to its maximum level. The value measured corresponds to the delivery rate of the device in l/min for the selected operating pressure. This value must not deviate by more than 10 % from the value indicated in section 4.1.

If the actual value is too low, this may be caused by deposits in the spray nozzle and/or in the filter element. Clean the parts and repeat the check. If the actual value is too high, this may be due to wear or damage to the spray nozzle.

When checking the nozzles, also check whether the spray nozzle is producing an even, fan-shaped spray pattern.

If the delivery rate is still too low after cleaning the nozzle and the filter element, or if the nozzle and/or the filter element are worn or damaged, replace the nozzle and/or the filter element by genuine SOLO replacement parts.

Changing the spray nozzle and the filter element:
See section 5.3

5.3 Changing the spray nozzle and the filter element

Only the standard spray nozzle (part no.: 49 00 525), the spray nozzles from the nozzle kit (part no.: 49 00 574) and the genuine filter element (part no.: 40 74 922 25, mesh aperture: 0.8 mm [0.031"]) must be used in this pressure sprayer.

Spray nozzle and filter element must only be changed if the device is depressurised. Depressurise the device by pulling on the pressure relief valve (Fig. 4).

Before pulling on the pressure relief valve (2), the device must always be in an upright position.

Attention: Keep the device away from your face!

Changing the spray nozzle or the filter element:

- Rinse the nozzle attachment with clean water.
- Disassemble the nozzle attachment (Fig. 2).
- Clean the O-rings, the filter element and the spray nozzle with clean water and a soft brush (Fig. 8). Never use your mouth to blow through the spray nozzle! Never use hard objects to clean the nozzles!
- Replace the previous nozzle by the new one or the previous filter element by the new one.
- Reassemble the components of the nozzle attachment (Fig. 2).

5.4 Greasing the pump gasket

To seal the spraying agent tank, always keep the pump gasket greased well with silicone grease.

5.5 Draining the spraying agent tank and cleaning the spraying agent carrying parts

Before opening the spraying agent tank and before disassembling the nozzle attachment, depressurise the device by pulling on the pressure relief valve (Fig. 4).

Before pulling on the pressure relief valve (2), the device must always be in an upright position. Attention: Keep the device away from your face!

Drain the spraying agent tank and all other spraying agent carrying parts daily after use and particularly at the end of the spraying season and thoroughly flush them with clean water.

Any unused spraying agent that is left over in the device could cause corrosion and hence damage the device. Special attention must be paid to wearing parts like spray nozzles, filters and seals.

Please read and observe the cleaning instructions supplied with the spraying agent.

Recommendation: Use the special SOLO cleaner for plant protection sprayers (dosing bottle of 500 ml [approx. 16.9 oz], part no.: 49 00 600).

Never use aggressive, acid- or solvent-containing cleaning agents (gasoline for example).

After cleaning, leave the spraying agent tank open to dry.

Cleaning the spray nozzle and the filter element:

- Rinse the nozzle attachment with clean water.
- Disassemble the nozzle attachment (Fig. 2).
- Clean the O-rings, the filter element and the spray nozzle with clean water and a soft brush (Fig. 8). Never use your mouth to blow through the spray nozzle! Never use hard objects to clean the nozzles!
- Reassemble the components of the nozzle attachment (Fig. 2).

5.6 Taking the sprayer out of service and putting it into storage

Prepare the device for storage according to section 5.5.

Store the device protected from sunlight in a secure, dry and frost-free location at a maximum ambient temperature of 35 °C [95 °F].



There must not be any open fires or similar nearby.

Ensure that the unit cannot be used by unauthorised persons, in particular children.

5.7 Maintenance plan

		Before you start working	After work	When changing the spraying agent	On demand	Monthly	Annually or at the start of the season
Entire pressure sprayer	Check whether the device is safe to use: <ul style="list-style-type: none"> • Visual inspection of the device • Check the tightness of all equipment components (at maximum permissible pressure with open and closed shut-off valve) • Check the function of all active components (pressure relief valve, shut-off valve, pump handle, pressure gauge (depending on the model)) 	X					
Hoses and their screw connectors	Visual inspection	X					
Spraying agent tank	Visual inspection	X					
	Clean (section 5.5)		X	X			
Nozzles and filter element	Clean (section 5.5)		X	X	X		
	Trial run to check the spray nozzles and the filter element by measuring the delivery rate (section 5.2) X*: A monthly trial run is required only if the device is used frequently.				X	X*	X
Pump gasket	Grease (section 5.4)				X		X

Never start working if there are any irregularities or leaks, if you can see any damage to the equipment or if the equipment is not working properly in any way. In this event, immediately depressurise the device by pulling on the pressure relief valve (Fig. 4) and have it checked by a specialist workshop.

Before pulling on the pressure relief valve (2), the device must always be in an upright position.

Attention: Keep the device away from your face!

If you have any questions please refer to your authorised SOLO dealer.

6 Standard delivery

- Standard device with shut-off valve assembled on the high-pressure hose
- Spray tube with assembled nozzle attachment
- These operating instructions (incl. EC declaration of conformity)

7 Specification and special accessories

Model ("Typ" ¹)		453
Spraying agent tank:	Tank volume ("Total Vol." ¹)	14.0 l [3.7 gal]
	Max. fill volume ("max. Vol." ¹)	11.0 l [2.9 gal]
Residual volume not properly discharged by the device		< 250 ml [8.5 oz]
Maximum permissible operating pressure ("P max." ¹)		2.0 bar [29 psi]
Permissible operating temperature ("T max." ¹)		0–40 °C [32–104 °F]
Spray tube (material: PP):	Length	500 mm [19.7"]
Pressure hose:	Length	2,500 mm [98"]
Standard spray nozzle (adjustable spray nozzle)	Part no.	49 00 525
Accessories: Nozzle kit (9 different nozzles)	Part no.	49 00 574
Maximum delivery with standard spray nozzle at 2 bar [29 psi] ("max." ¹)		0.7 l/min [0.185 USgal/min]
Filter element:	Mesh aperture	0.8 mm [0.031"]
	Part no.	40 74 922 25
Weight (ready for operation):	Tank empty ("net weight" ¹)	3.5 kg [7.7 lbs]
	tank filled to max.	14.5 kg [32 lbs]
Dimensions (without spray tube and pressure hose):	Height	880 mm [34.6"]
	Width	320 mm [12.6"]
	Depth	360 mm [14.2"]

¹ Inscription on the spraying agent tank

8 Wearing parts

Various parts are subject to application-specific wear or to normal wear and must be replaced in good time if necessary.

The following parts are subject to normal wear and are not covered by the manufacturers guarantee:

- All rubber parts that come into contact with the spraying agent
- Spray nozzle
- Filters
- Seals

9 Warranty

We warrant problem free quality and will cover the cost of replacing parts which are found to be faulty in material or show manufacturing defects within the prescribed guarantee period after the date of purchase.

Please note that specific guarantee conditions may differ from country to country. When in doubt, please ask the vendor of the goods. The vendor of the product is responsible for guarantee applications.

We hope you will understand that we cannot be liable for damage resulting from these causes:

- Non-compliance with operating instructions.
- Neglecting required maintenance and repair jobs.
- Wear from normal use (particularly: gasket seals, membranes, collars, spray nozzles and filters).
- Using non-approved tools.
- Use of force, improper treatment, misuse and accidents.
- Attempted adjustments and repairs by non-qualified persons.
- Unauthorized modification or changes made to the device.
- Use of unsuitable spare parts or non-genuine parts if such parts are the cause of the damage.
- Use of non-approved media in the spraying agent tank.
- Damage caused by using the product in the hire or rental industry.

Normal cleaning, adjustments or maintenance jobs cannot be claimed as part of the guarantee.

All guarantee work must be carried out by one of our authorised service centres.

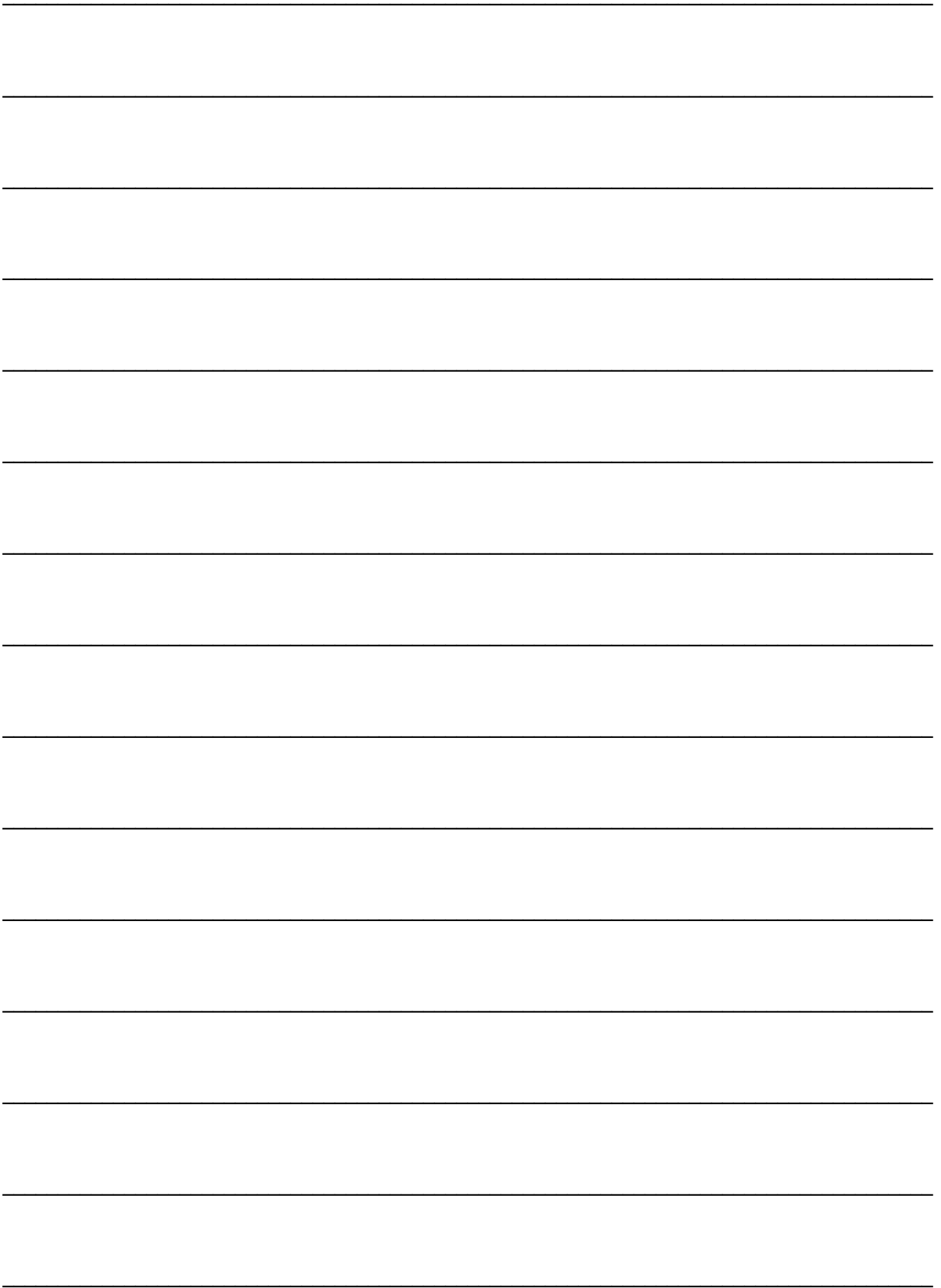

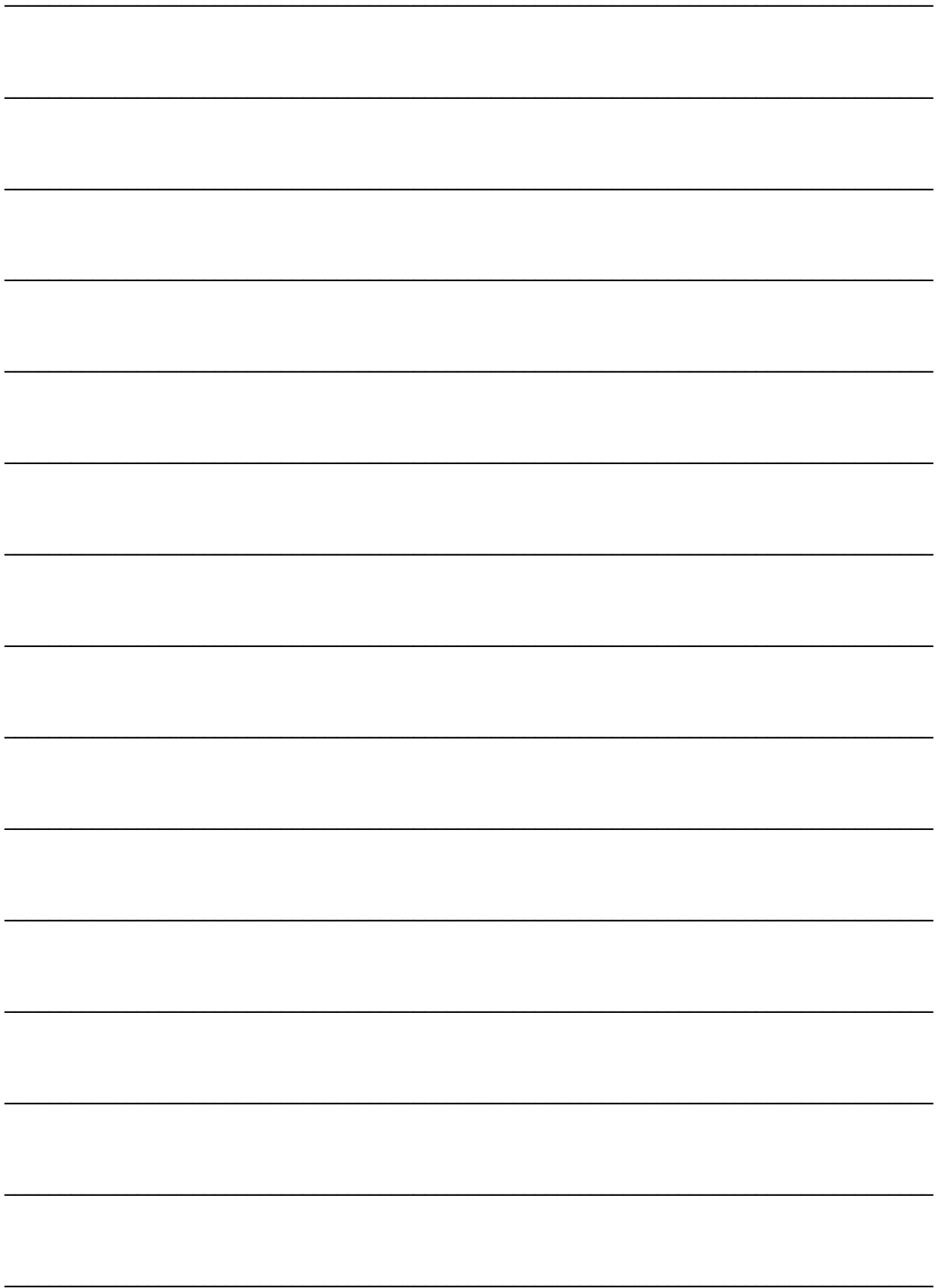

solo[®]



SOLO Kleinmotoren GmbH
Postfach 60 01 52
71050 Sindelfingen
DEUTSCHLAND
Tel.: +49 7031 301-0
Fax: +49 7031 301-130
info@solo-germany.com

SOLO Kleinmotoren GmbH
PO Box 60 01 52
71050 Sindelfingen
GERMANY
Tel.: +49 7031 301-0
Fax: +49 7031 301-149
export@solo-germany.com